



SanJePlas[®]
COMPACTOS, PERSIANAS, MOSQUITERAS, MAMPARAS

FABRICACIÓN Y COMERCIALIZACIÓN DE:

PERSIANAS Y ACCESORIOS
COMPACTOS
MOSQUITERAS
VENECIANAS
ARTÍCULOS DE DECORACIÓN
TOLDOS
MAMPARAS

SanJePlas[®]
COMPACTOS, PERSIANAS, MOSQUITERAS, MAMPARAS

Índice

PERSIANAS TIPO COMPACTO Y MINI	4
PAÑOS DE PERSIANAS	6
ACCESORIOS DE PERSIANAS	8
MATERIAL EN LARGO DE PERSIANAS	12
GUÍAS	13
MOSQUITERAS ENROLLABLES	14
MOSQUITERAS CORREDERAS	15
MOSQUITERAS PUERTAS	16
MATERIAL EN LARGO DE MOSQUITERAS	17
PERSIANAS DE CADENILLA	18
VENECIANAS	19
PUERTAS PLEGABLES DE PVC	20
CORTINAS	22
CELOSÍAS	24
CHAPAS DE ALUMINIO Y VISERAS	25
MOTORES	26
DECORACIÓN	27
CARTA DE COLORES	29
DESCUENTOS Y CONDICIONES DE VENTA	30
HOJA DE PEDIDO	31

PERSIANAS TIPO COMPACTO Y MINI

Cajón mini de aluminio de 4 partes



Cajón decorativo

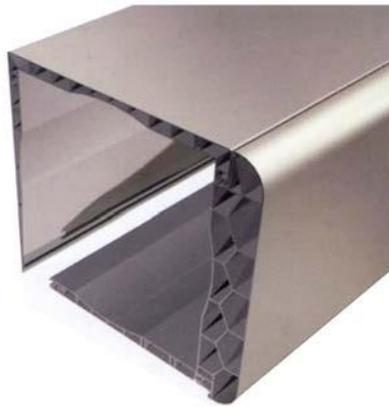

Cajón de PVC

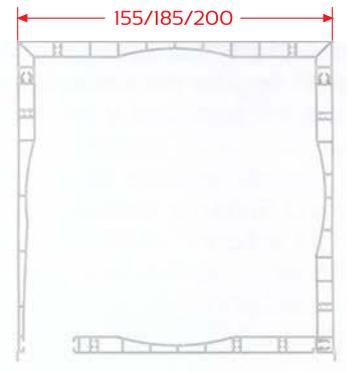
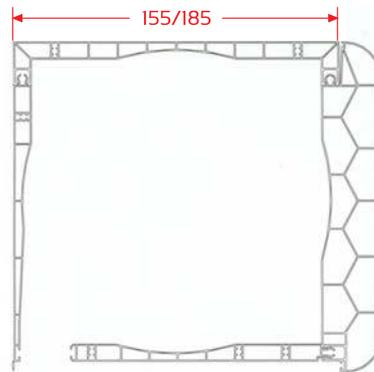

MONTAJE CAJÓN

Mini

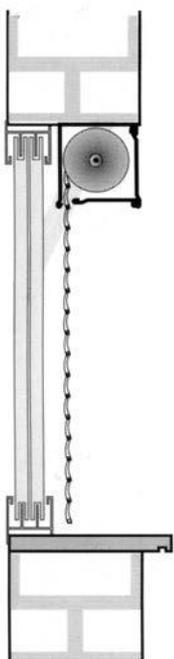

Mini montado al revés

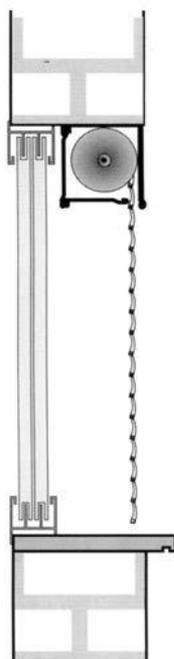

Compacto

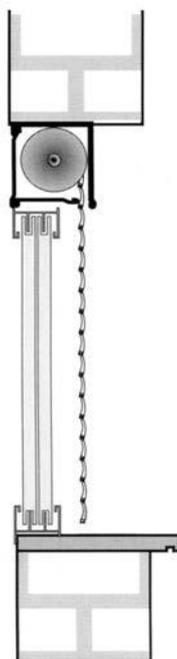

Cajón Aislabox

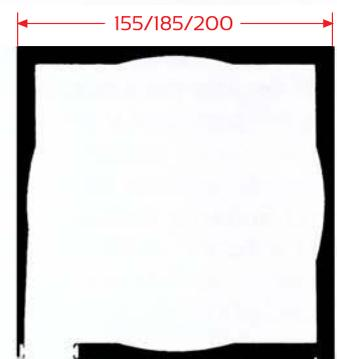

ENROLLAMIENTO

MEDIDAS

MODELO	CAJÓN DE ALUMINIO			CAJÓN DE PVC		CAJÓN ALUTÉRMICO	
	137	165	180	155	185	155	185
LAMA DE PVC.....	170	230	290	170	260	170	260
LAMA DE ALUMINIO.....	170	230	290	170	260	170	260

COMPACTOS

PRECIO M²

	LAMA PVC 39		LAMA ALUMINIO 45			
	BLANCO	MARFIL GRIS	BLANCO	MARFIL PLATA BRONCE	RAL NORMAL.	MADERA
CAJÓN DE ALUMINIO PERFILADO...	41,34 €	43,03 €	52,47 €	55,54 €	62,97 €	72,91 €
CAJÓN DE DT PVC.....	41,34 €	43,03 €	52,47 €	55,54 €	62,97 €	72,91 €
CAJÓN AISLABOX.....	-	-	67,03 €	71,05 €	81,07 €	92,51 €
CAJÓN DECORATIVO.....	-	-	62,45 €	-	-	-
CAJÓN ALUMINIO O PVC/S GUÍA ...	35,57€	37,27 €	43,46 €	48,08 €	56,75 €	61,37 €

MINIS

PRECIO M²

	LAMA PVC 39		LAMA ALUMINIO 45			
	BLANCO	MARFIL GRIS	BLANCO	MARFIL PLATA BRONCE	RAL NORMAL.	MADERA
CAJÓN DE ALUMINIO PERFILADO...	35,42 €	35,42 €	45,89 €	50,50 €	55,09 €	60,98 €
CAJÓN DE DT PVC.....	35,42 €	35,42 €	45,89 €	50,50 €	55,09 €	60,98 €
CAJÓN AISLABOX.....	-	-	65,38 €	71,95 €	78,49 €	86,85 €

Mínimo a facturar en compactos y minis: 1,25 m².

Se facturarán las medidas en múltiplos de 5 cm. en 5 cm. I.V.A. no incluido

RAL normalizado: 1015, 3005, 3009, 6009, 7011, 7040, 8014, 8017, 9011, INOX y ORO. Otros RALES consultar.

PAÑOS DE PERSIANAS

Lama de aluminio de 45 mm.

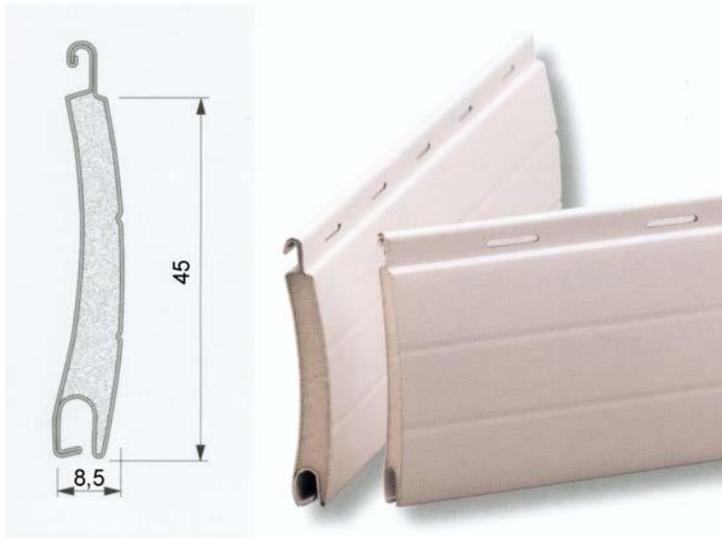

Lama Autoblocante

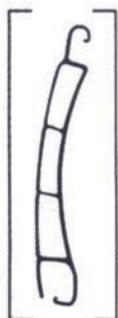
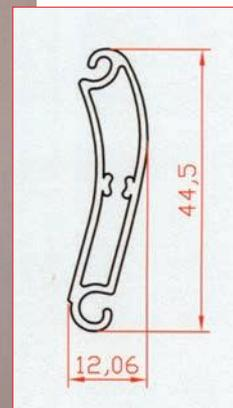

Lama Limi PVC de 39 mm.

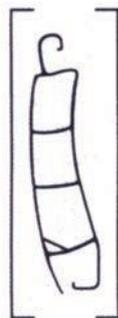

Lama Obra PVC de 50 mm.



Lama Extrusionada

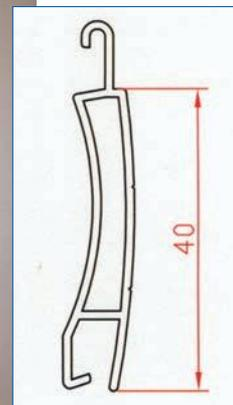

PAÑO LAMA DE OBRA K-50

PRECIO M²

BLANCO / MARFIL / GRIS / MADERA
19,30 €

PAÑO LAMA PVC DE MINI

PRECIO M²

BLANCO / MARFIL / GRIS / MADERA
15,80 €

PAÑO LAMA DE ALUMINIO / M-45

PRECIO M²

LACADO
BLANCO
34,82 €

RAL
NORMALIZADO
34,82 €

MADERAS
34,82 €

PAÑO LAMA AUTOBLOCANTE

PRECIO M²

LACADO
BLANCO
190,78 €

RAL
NORMALIZADO
228,94 €

MADERAS
263,28 €

PAÑO LAMA EXTRUSIONADA

PRECIO M²

LACADO
BLANCO
144,62 €

RAL
NORMALIZADO
173,54 €

MADERAS
199,58 €

Mínimo a facturar en paños: 1,00 m².

Se facturarán las medidas de 5 cm. en 5 cm.

RAL normalizado: 1015, 3005, 3009, 6009, 7011, 7040, 8014 y 8017. Otros RALES consultar.

Todos los paños incluyen topes, flejes y terminal.

I.V.A. no incluido.

ACCESORIOS DE PERSIANAS

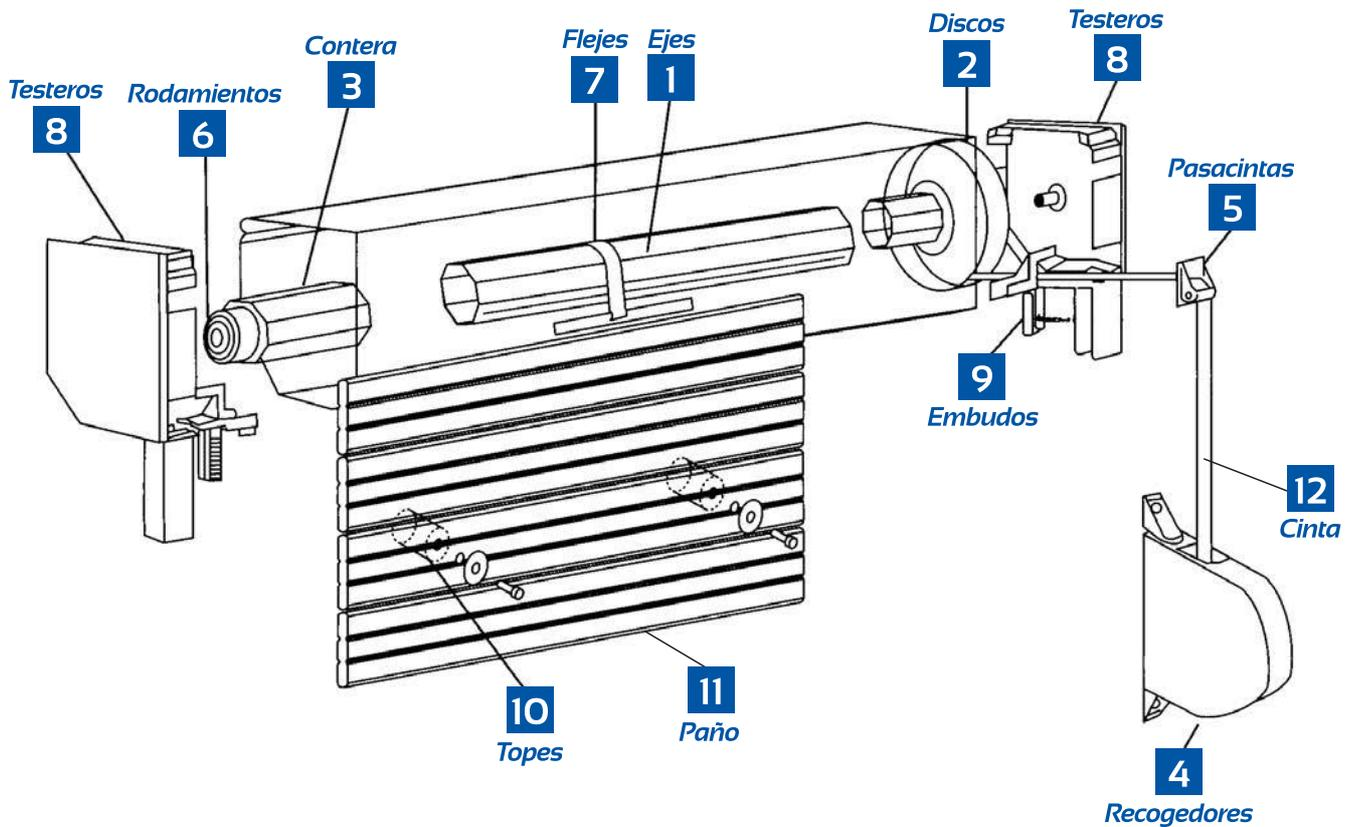

EJES Y DISCOS

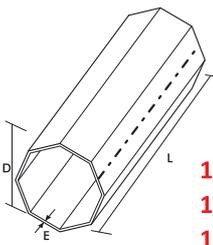

Eje octogonal
(taladro nacional y exportación)

	Medidas	Precio
18.101	D=42 - E=0,4 - L=6 m.	2,12 €
17.122	D=50 - E=0,4 - L=6 m.	3,88 €
17.120	D=60 - E=0,4 - L=6 m.	3,99 €

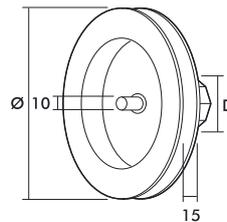

Disco metálico con espiga
para cinta de 14 mm.

	Medidas	Precio
18.110	Ø=110 - D=40 Oct	1,39 €
18.111	Ø=140 - D=40 Oct	1,58 €

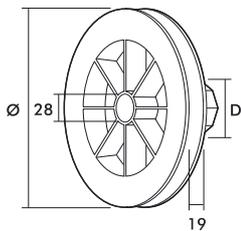

REFERENCIA > 19.105

Disco de compacto con rodamiento
y cinta de 18 mm.

	Medidas	Precio
	Ø=120 - D=40 Oct	1,57 €

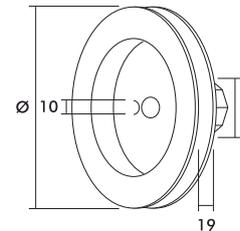

REFERENCIA > 19.100

Disco de compacto con espiga
para cinta de 18 mm.

	Medidas	Precio
	Ø=120 - D=40 Oct	1,82 €

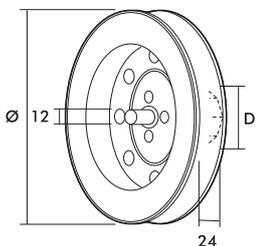

REFERENCIA > 17.100

Disco de obra metálico
para cinta de 22 mm.

	Medidas	Precio
	Ø=150 - D=60 Oct	3,58 €

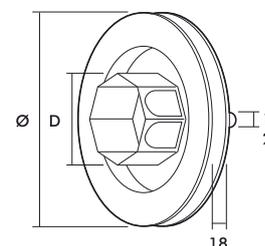

REFERENCIA > 17.101

Disco de obra metálico para cable

	Medidas	Precio
	Ø=150 - D=60 Oct	3,33 €

CONTERAS

REFERENCIA > 19.112

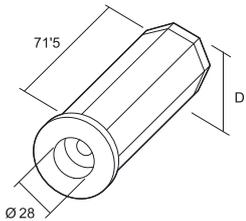

Contera compacto para rodamiento

Medidas	Precio
D=40 Oct	1,18 €

REFERENCIA > 18.120

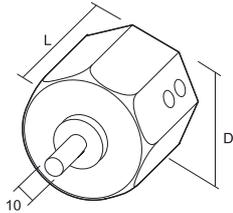

Contera mini metálica

Medidas	Precio
D=40 Oct	0,71 €

REFERENCIA > 17.110

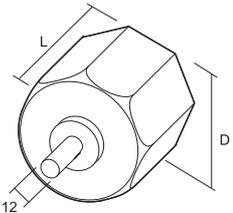

Contera metálica de obra

Medidas	Precio
D=60 Oct	1,46 €

REFERENCIA > 17.113

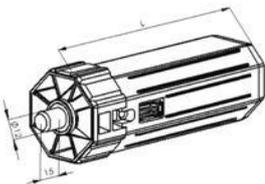

Contera de compacto con espiga

Medidas	Precio
D=50 Oct	1,72 €

REFERENCIA > 17.112

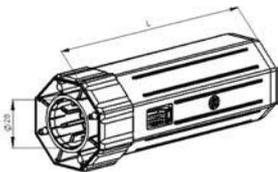

Contera con rodamiento

Medidas	Precio
D=50 Oct	1,36 €

RODAMIENTOS

REFERENCIA > 18.180

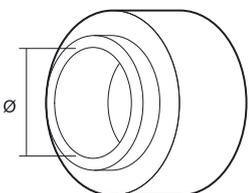

Rodamiento

Color	Precio
---	0,20 €

PASACINTAS

REFERENCIA > 18.140

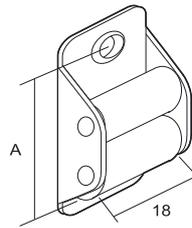

Pasacintas metálico para cinta de 14 mm.

Color	Precio
---	0,61 €

Pasamuro para cinta de 14 y 18 mm.

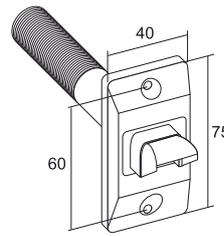

Color Blanco	Precio
18.141 C/14	2,80 €
19.137 C/18	2,80 €

Pasacintas para cajón de aluminio

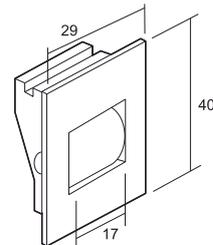

Color	Precio
19.154 Blanco	0,74 €
19.151 Gris	
19.152 Marrón	
19.153 Marfil	

Pasacintas para cajón de PVC

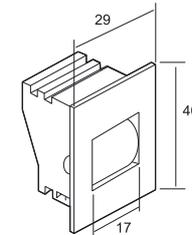

Color	Precio
19.155 Blanco	0,74 €
19.156 Gris	
19.156 Marrón	
19.156 Marfil	

REFERENCIA > 19.150

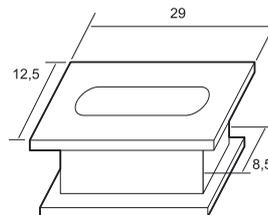

Ovalillo

Color	Precio
Blanco	0,74 €
Gris	
Marrón	
Negro	
Marfil	

REFERENCIA > 17.130

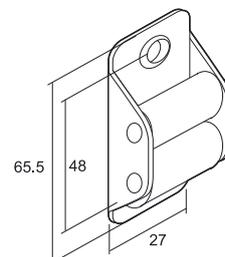

Pasacinta metálico para cinta de 22 mm.

Medidas	Precio
Blanco	0,86 €

ACCESORIOS DE PERSIANAS

RECOGEDORES

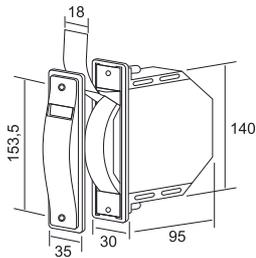

REFERENCIA > 19.143

Recogedor embutido compacto cinta de 18 mm.

Color	Precio
Blanco	5,79 €
Gris	
Marrón	
Negro	
Marfil	

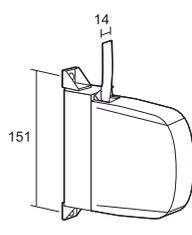

Recogedor mini cinta de 14 mm.

Color	Precio
18.131 Blanco	5,45 €
18.132 Gris	
18.133 Marrón	
18.130 Marfil	

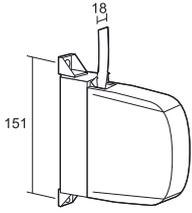

Recogedor abatible cinta de 18 mm.

Color	Precio
19.145 Blanco	5,79 €
19.148 Gris	
19.149 Marrón	
19.140 Marfil	

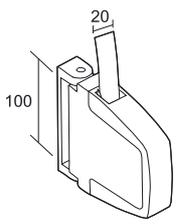

Recogedor abatible cinta de 20 mm.

Color	Precio
19.146 Blanco	11,38 €
19.147 Marfil	

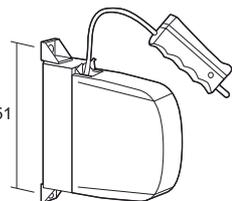

REFERENCIA > 18.135

Recogedor mini para cordón

Color	Precio
Marfil	13,08 €

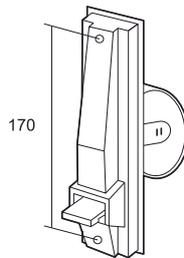

REFERENCIA > 17.140

Recogedor de plástico de empotrar para cinta de 22 mm.

Medidas	Precio
Blanco	3,59 €

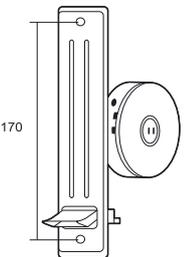

REFERENCIA > 17.141

Recogedor metálico de empotrar para cinta de 22 mm.

Precio
3,53 €

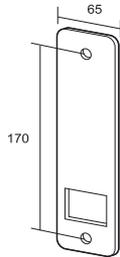

Placa para recogedor metálico

Colores	Precio
17.143 Natural	0,79 €
17.143 Blanco	1,83 €
17.144 Bronce	2,86 €

Testereros

Referencia	Precio
137	6,50 €
165	8,28 €
180	9,74 €
DT/PVC 155	5,25 €
DT/PVC 185	8,49 €
DT/ALUMINIO 155	13,11 €
DT/ALUMINIO 185	16,50 €

Felpudos

Referencia	Precio
4x6 GUÍA FLECHA	0,19 €/ml.
4,8x8 GUÍA MOSQUITERA	0,40 €/ml.
5x9 GUÍA PERSIANAS	0,27 €/ml.

Goma de Terminal 4,4

Precio
0,62 €/ml.

TOPES

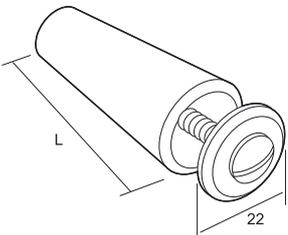

Tope de plástico con arandela

Referencia	Medidas	Precio
17.161	L=40 - Blanco	0,20 €
17.160	L=40 - Marfil	
17.162	L=40 - Gris	
17.164	L=40 - Bronce	
17.167	L=40 - Marrón Claro	
17.163	L=40 - Marrón Oscuro	
17.165	L=40 - Verde	0,52 €
	L=60 - Blanco	
	L=60 - Marfil	

EMBUDOS

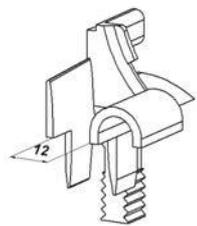

REFERENCIA > 19.134

Juego de embudos para compacto
cajón de aluminio

Precio
0,72 €

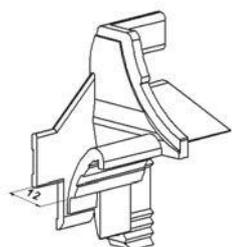

REFERENCIA > 19.132

Juego de embudos
para testero enrasado

Precio
0,72 €

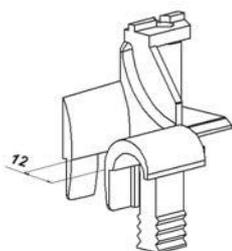

REFERENCIA > 19.131

Juego de embudos con rodillos

Precio
2,02 €

CINTAS

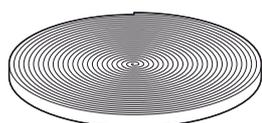

REFERENCIA > 18.150

Cinta de 14 mm.

Color
Gris

Precio
0,20 €/ml.

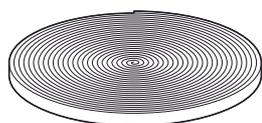

REFERENCIA > 18.151

Cinta de 18 mm.

Color
Pintas

Precio
0,22 €/ml.

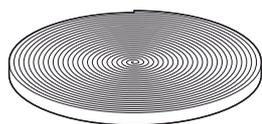

REFERENCIA > 17.210

Cinta de 22 mm.

Color
Gris cantos Blancos Extras

Precio
0,38 €/ml.

FLEJES

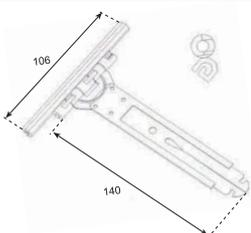

REFERENCIA > 19.122

Fleje tirante mixto

Precio
0,69 €
unidad

SOPORTES

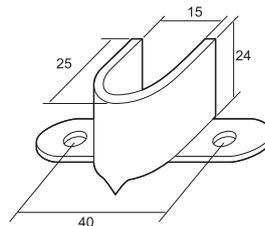

REFERENCIA > 17.150

Soporte de pincho

Precio
0,46 €

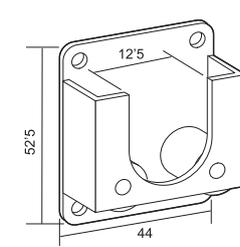

REFERENCIA > 17.152

Soporte de roldanas

Precio
1,97 €

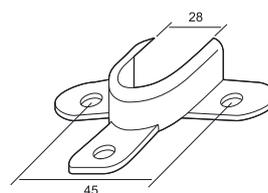

REFERENCIA > 17.151

Soporte para rodamiento

Precio
1,97 €

TORNOS

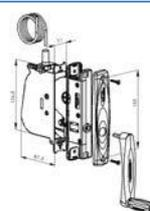

REFERENCIA > 17.174

Torno integral de compacto

Precio
43,53 €

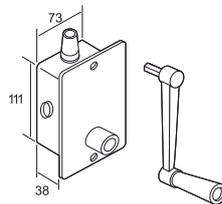

REFERENCIA > 17.170

Torno para empotrar

Precio
31,17 €

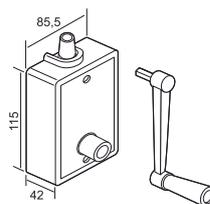

REFERENCIA > 17.171

Torno para exterior

Precio
31,17 €

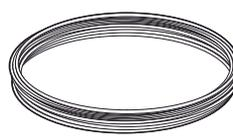

REFERENCIA > 17.172

Cable de acero para torno

Precio
4,24 €

MATERIAL LARGO PERSIANAS

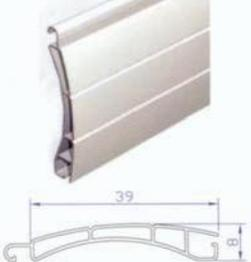

LAMA MINI PVC 39 mm.

MARFIL	BLANCO	GRIS	MARRON
0,46 €	0,46 €	0,46 €	0,50 €

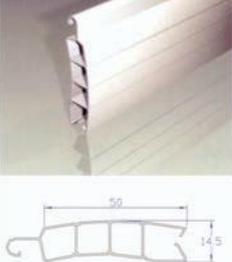

LAMA K-50 OBRA

MARFIL	BLANCO	GRIS	MARRON
0,76 €	0,76 €	0,76 €	0,82 €

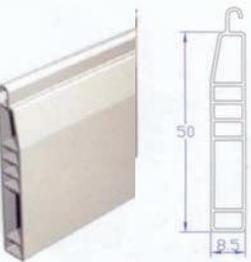

TERMINAL MINI PVC

MARFIL	BLANCO	GRIS	MARRON
0,69 €	0,69 €	0,69 €	0,74 €



TERMINAL OBRA PVC

MARFIL	BLANCO	GRIS	MARRON
1,08 €	1,08 €	1,08 €	1,16 €



LAMA ALUMINIO 45 mm.

MARFIL	BLANCO	PLATA	BRONCE	RAL NOR.	MADERA
1,37 €	1,14 €	1,47 €	1,47 €	1,56 €	1,80 €



LAMA PS-40 EXTRUSIÓN

MARFIL	BLANCO	PLATA	BRONCE	RAL NOR.	MADERA
5,28 €	4,67 €	4,67 €	6,56 €	5,28 €	11,13 €

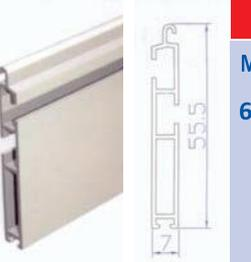

TERMINAL ALUMINIO

MARFIL	BLANCO	PLATA	BRONCE	RAL NOR.	MADERA
6,52 €	5,03 €	5,03 €	6,52 €	6,61 €	6,95 €



LAMA PS-40 AUTOBLOCANTE

MARFIL	BLANCO	PLATA	BRONCE	RAL NOR.	MADERA
8,55 €	6,08 €	6,08 €	9,57 €	8,55 €	16,44 €



CAJÓN ALUMINIO

MARFIL	BLANCO	PLATA	BRONCE	RAL NOR.	MADERA
137 21,31 €	21,31 €	21,31 €	21,31 €	27,70 €	30,50 €
165 25,50 €	25,50 €	25,50 €	25,50 €	33,11 €	36,42 €
180 28,20 €	28,20 €	28,20 €	28,20 €	36,71 €	40,37 €

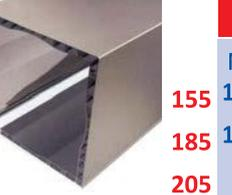

CAJÓN PVC

MARFIL	BLANCO	PLATA	BRONCE	RAL NOR.	MADERA
155 11,98 €	8,39 €	11,98 €	11,98 €	11,98 €	34,80 €
185 13,62 €	10,38 €	13,62 €	13,62 €	13,62 €	40,07 €
205 -	12,38 €	-	-	-	-

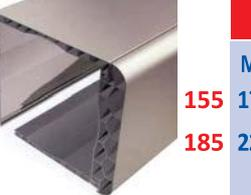

CAJÓN DECORATIVO

MARFIL	BLANCO	PLATA	BRONCE	RAL NOR.	MADERA
155 17,99 €	13,84 €	17,99 €	17,99 €	17,99 €	55,36 €
185 22,00 €	16,92 €	22,00 €	22,00 €	22,00 €	67,68 €

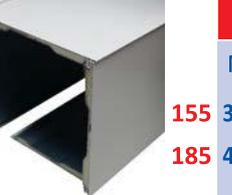

CAJÓN AISLABOX

MARFIL	BLANCO	PLATA	BRONCE	RAL NOR.	MADERA
155 39,16 €	39,16 €	39,16 €	39,16 €	50,92 €	54,83 €
185 44,53 €	44,53 €	44,53 €	44,53 €	56,16 €	63,63 €



EJE METÁLICO

40.....	2,12 €/ml.
50.....	3,88 €/ml.
60.....	4,00 €/ml.

RAL normalizado:
1015, 3005, 3009, 6009, 7011, 7040, 8014 y 8017.
Otros RALES consultar.

I.V.A. no incluido.

GUIAS

GUIAS PARA MOSQUITERAS

DESCRIPCIÓN	GUÍA MOSQUITERO					
	LACADO BLANCO	RAL NORMAL.	MADERA STANDAR	PLATA	ORO BRONCE	INOX.
	4,30 €	4,96 €	8,05 €	4,81 €	5,67 €	*

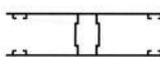
DESCRIPCIÓN	MAINEL DOBLE MOSQUITERO					
	LACADO BLANCO	RAL NORMAL.	MADERA STANDAR	PLATA	ORO BRONCE	INOX.
	7,68 €	8,91 €	14,59 €	8,61 €	10,21 €	*

GUIAS Y MARCOS PARA PERSIANAS

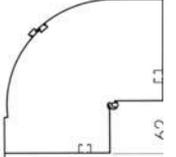
DESCRIPCIÓN	ESQUINERO REGULABLE 185					
	LACADO BLANCO	RAL NORMAL.	MADERA STANDAR	PLATA	ORO BRONCE	INOX.
	42,10 €	47,00 €	67,64 €	45,96 €	51,72 €	*

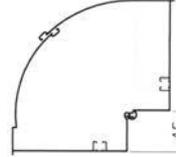
DESCRIPCIÓN	ESQUINERO REGULABLE 165					
	LACADO BLANCO	RAL NORMAL.	MADERA STANDAR	PLATA	ORO BRONCE	INOX.
	42,10 €	47,00 €	67,64 €	45,96 €	51,72 €	*

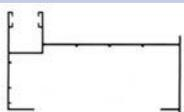
DESCRIPCIÓN	GUÍA PREMARCO 101 MM. REC. EMB.					
	LACADO BLANCO	RAL NORMAL.	MADERA STANDAR	PLATA	ORO BRONCE	INOX.
	10,40 €	11,65 €	19,80 €	10,40 €	13,20 €	*

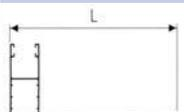
DESCRIPCIÓN	GUÍA PALA "L" RECOGEDOR ABATIBLE					
	LACADO BLANCO	RAL NORMAL.	MADERA STANDAR	PLATA	ORO BRONCE	INOX.
	L=60 L=120					
	7,10 €	8,19 €	13,17 €	7,92 €	9,34 €	*
	10,11 €	11,57 €	18,03 €	11,24 €	13,05 €	*

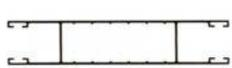
DESCRIPCIÓN	MAINEL					
	LACADO BLANCO	RAL NORMAL.	MADERA STANDAR	PLATA	ORO BRONCE	INOX.
	10,14 €	11,66 €	18,61 €	11,30 €	13,26 €	*

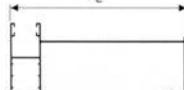
DESCRIPCIÓN	GUÍA PREMARCO "P" REC. EMB.					
	LACADO BLANCO	RAL NORMAL.	MADERA STANDAR	PLATA	ORO BRONCE	INOX.
	P=120 P=130					
	10,98 €	12,63 €	20,24 €	12,24 €	14,38 €	*
	12,94 €	14,80 €	23,23 €	14,38 €	16,73 €	*

DESCRIPCIÓN	GUÍA SIMPLE					
	LACADO BLANCO	RAL NORMAL.	MADERA STANDAR	PLATA	ORO BRONCE	INOX.
	5,20 €	6,04 €	10,03 €	5,83 €	6,95 €	*

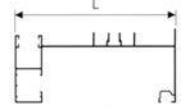
DESCRIPCIÓN	GUÍA MARCO "TRIANA"						
	LACADO BLANCO	RAL NORMAL.	MADERA STANDAR	PLATA	ORO BRONCE	INOX.	
							
	P=123 IZQUIERDA	13,67 €	15,71 €	25,01 €	15,26 €	17,85 €	*
	P=123 DERECHA	13,67 €	15,71 €	25,01 €	15,26 €	17,85 €	*
	P=132 IZQUIERDA	13,73 €	15,80 €	25,34 €	15,32 €	18,00 €	*
	P=132 DERECHA	13,73 €	15,80 €	25,34 €	15,32 €	18,00 €	*

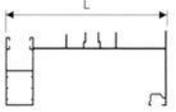
DESCRIPCIÓN	GUÍA MARCO "GIRALDA"						
	LACADO BLANCO	RAL NORMAL.	MADERA STANDAR	PLATA	ORO BRONCE	INOX.	
							
	P=120 IZQUIERDA	14,69 €	16,83 €	26,63 €	16,34 €	19,10 €	*
	P=120 DERECHA	14,69 €	16,83 €	26,63 €	16,34 €	19,10 €	*
	P=132 IZQUIERDA	15,42 €	17,64 €	27,61 €	17,13 €	19,91 €	*
P=132 DERECHA	15,42 €	17,64 €	27,61 €	17,13 €	19,91 €	*	

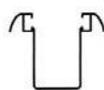
DESCRIPCIÓN	GUÍA FLECHA					
	LACADO BLANCO	RAL NORMAL.	MADERA STANDAR	PLATA	ORO BRONCE	INOX.
	2,60 €	3,08 €	5,38 €	2,96 €	3,60 €	*

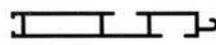
DESCRIPCIÓN	TERMINAL DE PERSIANA 50 MM.					
	LACADO BLANCO	RAL NORMAL.	MADERA STANDAR	PLATA	ORO BRONCE	INOX.
	4,41 €	5,11 €	8,30 €	4,93 €	5,85 €	*

PERFILES NORMALIZADOS "UES" Y TUBOS

DESCRIPCIÓN	PERFIL "U" 20 x 20 x 1,4					
	LACADO BLANCO	RAL NORMAL.	MADERA STANDAR	PLATA	ORO BRONCE	INOX.
	2,55 €			2,85 €		

DESCRIPCIÓN	TUBO CUADRADO 40 x 40 x 1,4					
	LACADO BLANCO	RAL NORMAL.	MADERA STANDAR	PLATA	ORO BRONCE	INOX.
	5,96 €	6,80 €	10,96 €	6,62 €	7,71 €	*

DESCRIPCIÓN	TUBO RECTANGULAR					
	LACADO BLANCO	RAL NORMAL.	MADERA STANDAR	PLATA	ORO BRONCE	INOX.
						
REF. 500.243 40X20	4,35 €	4,99 €	7,86 €	4,84 €	5,65 €	*
REF. 500.169 60X20	6,46 €	7,31 €	11,18 €	7,13 €	8,19 €	*

DESCRIPCIÓN	TUBO REDONDO Ø40					
	LACADO BLANCO	RAL NORMAL.	MADERA STANDAR	PLATA	ORO BRONCE	INOX.
	6,49 €	7,20 €	10,22 €	7,04 €	7,90 €	*

*Inox: preguntar precio y disponibilidad I.V.A. no incluido.

MOSQUITERAS CORREDERAS

>>>>> MOSQUITERA CORREDERA



- 1 Perfil corredera
- 2 Juego escuadra
- 3 Junta goma perfil mosquitera fija/corredera
- 4 Perfil mosquitera cepillo 48x8
- 5 Tejido mosquitera

PRECIO M²

LACADO BLANCO	PLATA BRONCE	RALES STANDAR	MADERA NOGAL PINO/EMBERO
28,66 €	30,20 €	43,85 €	46,15 €

Mínimo a facturar: 1,00 m². Especificar medida de hoja para el ancho y hueco luz en el alto. RAL normalizado: 1015, 3005, 3009, 6009, 7011, 7016, 7022, 7040, 8014 y 8017. Otros RALES consultar. I.V.A. no incluido.

MOSQUITERAS CORREDERAS DIVISIÓN CENTRAL: MÍNIMO A FACTURAR 1,50 M²

Cómo se mide una mosquitera corredera

La mosquitera corredera es una simple hoja que se adapta para correr sobre el borde o marco (no sobre carriles) de su puerta o ventana corredera. En tal caso prácticamente no existe instalación y el sistema para medirla es muy sencillo:

Para tomar la medida de **ANCHURA**: mida el ancho de una de las hojas de la ventana o puerta corredera.

Para tomar la medida de **ALTURA**: en su actual puerta o ventana corredera, mida en varios puntos la altura de la luz (la altura del hueco) que hay entre el marco de la parte superior y el existente en la parte inferior y tome como referencia la medida más pequeña (cuando decimos marco nos referimos al saliente más externo que hay hacia el interior de la casa, y por el cual NO corren las hojas del cerramiento).

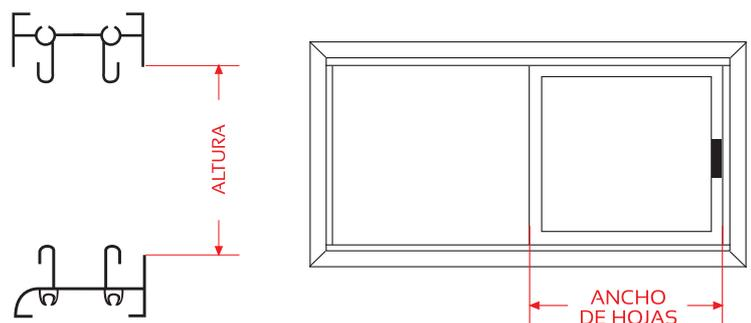

Recuerde anotar las medidas exactas en milímetros

MOSQUITERAS PUERTAS



Mosquitera Plisada



Mosquitera Puerta Abatible

PUERTAS	PRECIOS M ²			
	LACADO BLANCO	RAL NORMALIZADO	ANODIZADO	MADERAS
ABATIBLES	209 €	229 €	236 €	299 €
INCREMENTOS <i>Solape 3 cm.</i>	7,33 €/ml.	8,73 €/ml.	9,84 €/ml.	15 €/ml.
ENROLLABLES PARA PUERTAS	101,33 €	124 €	128 €	156 €
PUERTA LATERAL	131 €	152 €	157 €	187 €

PUERTA ABATIBLE 1 HOJA: Mínimo 1,50 m². - Ancho máximo 1,10 m. / PUERTA ABATIBLE 2 HOJAS: Mínimo 3 m². - Ancho máximo 2,20 m.
 ENROLLABLE PARA PUERTAS: Ancho máximo aconsejado 1,00 m. / Mínimo 1,50 m². sencilla - Mínimo 3 m². doble.
 PUERTA LATERAL SENCILLA: Mínimo 1,50 m². - Ancho máximo 160 m. / PUERTA LATERAL DOBLE: Mínimo 3 m². - Ancho máximo 3,20 m.
Resto de RAL se incrementará el precio del RAL normalizado en un 20%.

PRECIOS UNIDAD	PLISADAS 1 HOJA	BLANCO Y PLATA	BRONCE	RAL NORM.	MADERAS
		KIT 1,94 - 2,40 x 1,20	300 €	352 €	323 €
KIT 1,94 - 2,40 x 1,35	323 €	373 €	344 €	440 €	
KIT 1,94 - 2,40 x 1,90	425 €	499 €	469 €	572 €	

PRECIOS UNIDAD	PLISADAS 2 HOJAS	BLANCO Y PLATA	BRONCE	RAL NORM.	MADERAS
		KIT 1,94 - 2,40 x 2,40	600 €	704 €	645 €
KIT 1,94 - 2,40 x 2,70	645 €	746 €	688 €	880 €	
KIT 1,94 - 2,40 x 3,80	851 €	997 €	939 €	1144 €	

RAL normalizado: 1015, 3005, 3007, 3009, 5010, 6005, 6009, 7011, 7016, 7022, 7040, 8014, 8017, 8019, 9011 y grafito I.V.A. no incluido.

MATERIAL LARGO MOSQUITERAS

MOSQUITERA ENROLLABLE EN LARGO

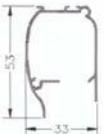
DESCRIPCIÓN	33 MINI (Altura 1,40 m.) PRECIOS €/ml.				
	LACADO BLANCO	PLATA	BRONCE	RAL NORMAL.	MADERAS
	23,62 €	26,77 €	26,77 €	32,07 €	41,43 €

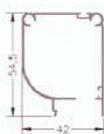
DESCRIPCIÓN	42 (Altura 2,40 m.) PRECIOS €/ml.				
	LACADO BLANCO	PLATA	BRONCE	RAL NORMAL.	MADERAS
	32,18 €	35,81 €	35,81 €	40,23 €	46,35 €

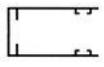
DESCRIPCIÓN	GUÍA LATERAL				
	LACADO BLANCO	PLATA	BRONCE	RAL NORMAL.	MADERAS
	5,45 €	6,06 €	6,06 €	6,83 €	11,05 €

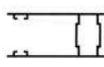
DESCRIPCIÓN	GUÍA CENTRAL				
	LACADO BLANCO	PLATA	BRONCE	RAL NORMAL.	MADERAS
	11,83 €	12,94 €	12,94 €	14,54 €	22,07 €

DESCRIPCIÓN	KIT 33
PRECIO UNIDAD	NEGRO > 7,64 €

DESCRIPCIÓN	KIT 42
PRECIO UNIDAD	NEGRO > 7,96 €

DESCRIPCIÓN	JUEGO DE FRENOS
PRECIO UNIDAD	NEGRO > 2,44 €

MOSQUITERA FIJA Y CORREDERA EN LARGO

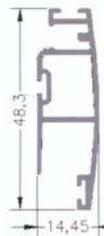
DESCRIPCIÓN	PERFIL MOSQUITERA CORREDERA PRECIOS €/ml.				
	LACADO BLANCO	PLATA	BRONCE	RAL NORMAL.	MADERAS
	4,26 €	4,62 €	5,48 €	7,72 €	8,04 €

DESCRIPCIÓN	PERFIL TRAVESAÑO PRECIOS €/ml.				
	LACADO BLANCO	PLATA	BRONCE	RAL NORMAL.	MADERAS
	3,02 €	3,67 €	4,67 €	6,14 €	6,22 €

DESCRIPCIÓN	JUEGO 4 ESCUADRAS MOSQUITERA CORREDERA
NEGRO > 3,44 €	BLANCO > 3,44 €

DESCRIPCIÓN	JUEGO 4 ESCUADRAS MOSQUITERA FIJA
NEGRO > 3,44 €	BLANCO > 3,44 €

DESCRIPCIÓN	RODAMIENTO MOSQUITERA
	0,84 €

DESCRIPCIÓN	PIEZA SUJECCIÓN PERFIL TRAVESAÑO
NEGRO > 0,18 €	BLANCO > 0,18 €

DESCRIPCIÓN	GOMA FIJACIÓN REDONDA DE 6,5 mm. NEGRO
	0,28 €

DESCRIPCIÓN	ROLLO FELPUDO 48 x 8
Precio ml.	0,40 €

DESCRIPCIÓN	ROLLO TELA 1,60 x 30
Precio m ² .	3 €

RAL normalizado: 1015, 3005, 3007, 3009, 5010, 6005, 6009, 7011, 7016, 7022, 7040, 8014, 8017, 8019, 9011 y grafito. Otros RALES consultar.

I.V.A. no incluido.

PERSIANAS DE CADENILLA

CADENILLA DE MADERA



CADENILLA DE PLÁSTICO



CADENILLA DE MADERA

PRECIOS M²

CADENILLA DE MADERA
SIN PINTAR..... 33,08 €

CADENILLA DE MADERA
PINTADA 36,16 €

CADENILLA
MEDIO PUNTO..... 60,77 €

CADENILLA DE PLÁSTICO

PRECIOS M²

CADENILLA DE PLÁSTICO
TODOS LOS COLORES..... 26,31 €

CADENILLA DE PLÁSTICO
MEDIO PUNTO..... 49,23 €

Mínimo a facturar: 1,00 m².
Se facturarán las medidas de 5 cm. en 5 cm.
I.V.A. no incluido.

VENECIANAS

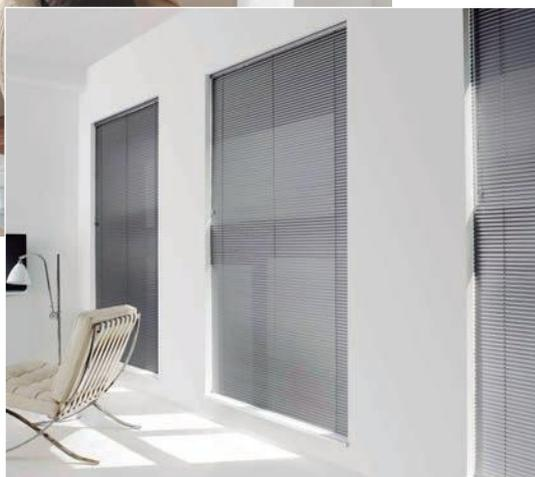

LAMA DE 16 mm.

PRECIOS M²

COLOR ESTÁNDAR.....	39,34 €
DOBLE COLOR ESTÁNDAR.....	45,90 €
COLOR ESPECIAL	51,28 €

LAMA DE 25 mm.

PRECIOS M²

COLOR ESTÁNDAR.....	25,91 €
DOBLE COLOR ESTÁNDAR.....	30,54 €
COLOR ESPECIAL	37,86 €

En estos dos modelos, si la persiana tiene un ancho inferior a 330 mm., se le aplicará un incremento ya que debe ser fabricada de forma manual completamente.

MEDIDAS ORIENTATIVAS MÍNIMAS Y MÁXIMAS RECOMENDADAS

Para medidas superiores a las indicadas, la empresa no se responsabiliza del funcionamiento.

	16 mm.		25 mm.	
	MÍNIMO	MÁXIMO	MÍNIMO	MÁXIMO
SUPERFICIE		3		3
ANCHO mm.	300	1600	330	1600
ALTO mm.		2500		2500

MEDIDAS ORIENTATIVAS MÍNIMAS Y MÁXIMAS QUE SE PUEDEN FABRICAR

	16 mm.		25 mm.	
	MÍNIMO	MÁXIMO	MÍNIMO	MÁXIMO
SUPERFICIE		3		3
ANCHO mm.	300	1600	330	1600
ALTO mm.		2500		2500

Para colores especiales, especificar color del cabezal y zócalo.
Mínimo a facturar: 1,00 m².
Se facturarán las medidas de 5 cm. en 5 cm.
I.V.A. no incluido.

PUERTAS PLEGABLES DE PVC

COLORES LACADOS

CEREZO

HAYA

SAPELY

ROBLE

NOGAL

PINO

MARFIL

BLANCO

COLORES FOLIADOS

PINO NUDO

HAYA

ROBLE

CEREZO

GOLDEN

NOGAL

WENGUÉ



Ciega

Con Vidriera



MODELO CIEGA

PRECIOS €/unidad	ALTURA					
	HASTA 2,10		HASTA 2,30		HASTA 2,55	
	LACADA	REVESTIDA	LACADA	REVESTIDA	LACADA	REVESTIDA
0,60	124 €	158 €	129 €	166 €	135 €	176 €
0,70	134 €	175 €	140 €	184 €	147 €	195 €
0,80	144 €	191 €	150 €	201 €	158 €	213 €
0,90	155 €	208 €	161 €	219 €	170 €	233 €
1,00	164 €	224 €	172 €	236 €	181 €	251 €
1,10	175 €	241 €	183 €	254 €	193 €	271 €
1,20	197 €	268 €	205 €	282 €	216 €	301 €
1,30	207 €	285 €	217 €	301 €	229 €	320 €
1,40	217 €	300 €	227 €	317 €	239 €	338 €
1,50	227 €	318 €	238 €	336 €	252 €	358 €
1,60	237 €	333 €	248 €	352 €	263 €	376 €
1,70	248 €	350 €	260 €	371 €	275 €	396 €
1,80	257 €	366 €	270 €	387 €	286 €	414 €
1,90	268 €	383 €	281 €	406 €	298 €	434 €
2,00	277 €	399 €	291 €	422 €	308 €	452 €
2,10	288 €	416 €	302 €	441 €	321 €	471 €
2,20	297 €	431 €	312 €	457 €	331 €	490 €
2,30	321 €	460 €	336 €	487 €	356 €	521 €
2,40	330 €	476 €	346 €	504 €	367 €	539 €
2,50	341 €	494 €	358 €	522 €	379 €	559 €
2,60	350 €	508 €	368 €	539 €	390 €	577 €
2,70	361 €	526 €	379 €	557 €	402 €	596 €
2,80	370 €	541 €	389 €	574 €	413 €	615 €
2,90	381 €	559 €	401 €	592 €	425 €	634 €
3,00	390 €	574 €	411 €	609 €	436 €	652 €

MODELO CON VIDRIERA

PRECIOS €/unidad	ALTURA					
	HASTA 2,10		HASTA 2,30		HASTA 2,55	
	LACADA	REVESTIDA	LACADA	REVESTIDA	LACADA	REVESTIDA
0,60	171 €	204 €	176 €	211 €	198 €	236 €
0,70	193 €	232 €	199 €	241 €	226 €	271 €
0,80	214 €	259 €	221 €	269 €	252 €	305 €
0,90	237 €	288 €	244 €	299 €	280 €	339 €
1,00	258 €	315 €	266 €	327 €	307 €	373 €
1,10	281 €	343 €	289 €	357 €	334 €	408 €
1,20	314 €	382 €	323 €	396 €	373 €	453 €
1,30	337 €	410 €	346 €	426 €	401 €	487 €
1,40	358 €	437 €	368 €	454 €	427 €	521 €
1,50	380 €	466 €	391 €	484 €	455 €	556 €
1,60	402 €	493 €	413 €	512 €	482 €	589 €
1,70	424 €	521 €	436 €	542 €	510 €	624 €
1,80	445 €	548 €	458 €	570 €	536 €	657 €
1,90	468 €	577 €	481 €	599 €	564 €	692 €
2,00	489 €	604 €	503 €	627 €	591 €	725 €
2,10	511 €	632 €	526 €	657 €	618 €	760 €
2,20	532 €	659 €	547 €	685 €	645 €	794 €
2,30	567 €	700 €	583 €	727 €	685 €	840 €
2,40	588 €	726 €	605 €	755 €	712 €	873 €
2,50	611 €	755 €	628 €	784 €	740 €	908 €
2,60	632 €	782 €	650 €	812 €	766 €	941 €
2,70	655 €	811 €	673 €	842 €	794 €	976 €
2,80	676 €	838 €	695 €	870 €	820 €	1010 €
2,90	699 €	866 €	718 €	900 €	849 €	1045 €
3,00	720 €	893 €	740 €	928 €	875 €	1078 €

INCREMENTOS

CERRADURA A LLAVE..... 20 € / unidad

Colores de maneta: Plata y Oro. En caso de no indicarse nada, se colocará la maneta Plata.
Colores de cristal: Transparente y Ámbar. En caso de no indicarse nada, se colocará el cristal Transparente.
Máxima altura de fabricación: 2,55 m/l.

Las puertas que sean solicitadas con apertura central, se ubicarán como dos puertas independientes.
A efectos de cobro, se redondeará a la inmediata superior.

I.V.A. no incluido.

CORTINAS



KARLA Y DIANA
 PRECIOS m².

SENCILLA40 €
DOBLE58,50 €

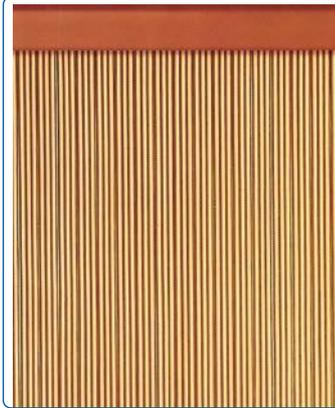
IRIS
 PRECIOS m².

CINTA BICOLOR SENCILLA43 €
CINTA BICOLOR DOBLE59 €

MARBELLA
 PRECIOS m².

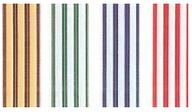
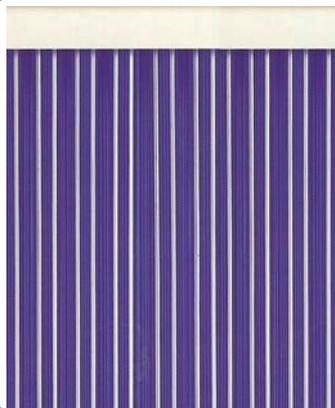
CINTA BICOLOR SENCILLA43 €
CINTA BICOLOR SEMIDOBLE..59 €



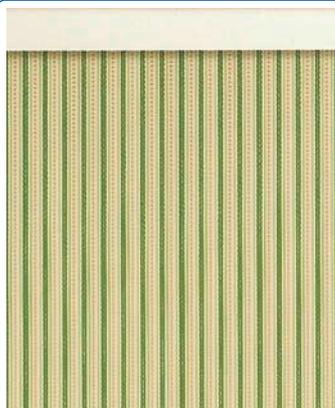

MEDITERRANEO
 PRECIOS m².

CINTA ESPECIAL SENCILLA.....43 €
CINTA ESPECIAL SEMIDOBLE ...59 €

OLIMPIA
 PRECIOS m².

CINTA LUJO60 €

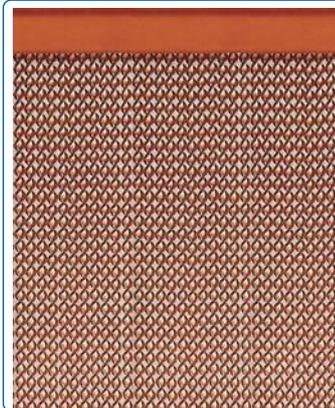
IBIZA
 PRECIOS m².

TUBO BICOLOR.....69 €





SOFIA
 PRECIOS m².

TUBO MACARRON.....69 €

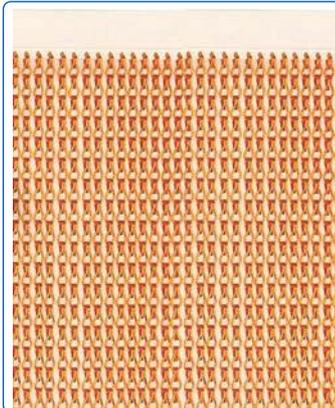

Transparente Opaco Metalico



KRISOL ANONIZADA
 PRECIOS m².

.....85 €



MANACOR

PRECIOS m².

TUBO LUJO89,20 €



ALASKA

PRECIOS m².

CORDON MULTICOLOR.....80 €



VENECIANA

PRECIOS m².

TUBO BRILLANTE89,20 €



ALICANTINA

PRECIOS m².

CANUTILLO LISO
BICOLOR JASPEADO61,50 €



MIAMI

PRECIOS m².

CANUTILLO83 €



BRASILIA

PRECIOS m².

.....103 €



Mínimo a facturar: 1,50 m².

Se facturarán las medidas en múltiplos de 5 cm. en 5 cm.

I.V.A. no incluido.

Las cortinas solicitadas combinadas con más de dos colores, incrementarán en 3 €/m².

CELOSÍAS

LAMAS PVC

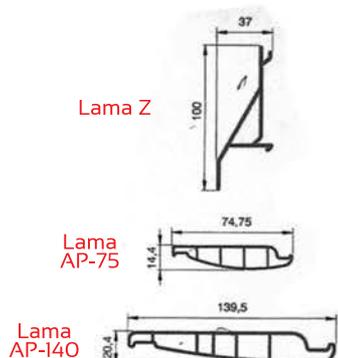

FIJA PVC Y ALUMINIO

PRECIOS M²

<i>Montados en marco de aluminio de 40x40</i>	BLANCO Y PLATA	RAL NORMAL.	ANONIZADO	MADERAS
	LAMA Z PVC	138 €	-	-
LAMA Z ALUMINIO.....	203 €	237 €	253 €	352 €
LAMA C ALUMINIO	203 €	237 €	253 €	352 €
LAMA I ALUMINIO	203 €	237 €	253 €	352 €
LAMA I ALUMINIO MICROPERFORADO	264 €	307 €	333 €	460 €
LAMA S ALUMINIO.....	203 €	237 €	253 €	352 €
LAMA D-5 ALUMINIO (SISTEMA REJA).....	208 €	247 €	253 €	387 €
LAMA V-5 ALUMINIO	286 €	349 €	367 €	580 €

LAMAS ALUMINIO

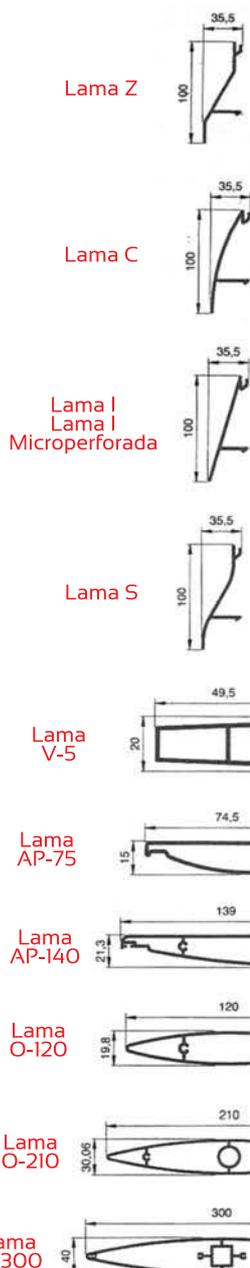

MÓVIL PVC Y ALUMINIO

PRECIOS M²

<i>Montados en marco de aluminio de 40x40</i>	BLANCO Y PLATA	RAL NORMAL.	ANONIZADO	MADERAS
	LAMA D-7 ALUMINIO	287 €	318 €	327 €
LAMA AP-75 PVC (SISTEMA PIVOTE).....	180 €	-	-	-
LAMA AP-75 ALUMINIO (SISTEMA PIVOTE).....	267 €	297 €	323 €	547 €
LAMA AP-140 PVC (SISTEMA PIVOTE).....	167 €	-	-	-
LAMA AP-140 PVC (SISTEMA REJA).....	214 €	-	-	-

MÓVIL ALUMINIO

PRECIOS M²

<i>Montados en marco de aluminio de 50x40</i>	BLANCO Y PLATA	RAL NORMAL.	ANONIZADO	MADERAS
	LAMA AP-140 PVC (SISTEMA PIVOTE).....	267 €	296 €	324 €
LAMA AP-140 ALUMINIO (SISTEMA REJA).....	300 €	329 €	357 €	580 €
LAMA O-120 ALUMINIO (SISTEMA PIVOTE).....	304 €	333 €	360 €	580 €
LAMA O-120 ALUMINIO (SISTEMA REJA).....	337 €	367 €	393 €	613 €
LAMA O-210 ALUMINIO (SISTEMA REJA).....	364 €	396 €	427 €	644 €

INCREMENTOS

Cardán Celosía.....120 € unidad
 Solape de 30 cm.....s/color
 Motores interiores491 € unidad
 Motores exteriores.....1213 € unidad

Mínimo a facturar: 1,00 m².
 I.V.A. no incluido.
 Resto RAL se incrementa 20%.

CHAPAS DE ALUMINIO Y VISERAS

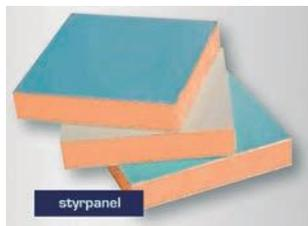

CHAPAS DE ALUMINIO

	2x1 1 CARA	2x1 2 CARAS	3x1,25 1 CARA	3x1,25 2 CARAS
CHAPA BLANCA - 0,8	32,45 €	48 €	71,67 €	91,15 €/1mm.
CHAPA PLATA - 0,8.....	57,47 €	48 €	96,32 €	121,67 €/0,9mm.
CHAPA NOGAL - 0,8.....	93,12 €	142,17 €	185,05 €	327,12 €
CHAPA RAL 1015, 6009				
8014, 8017 - 0,8	59,05 €	74,87 €	100,35 €* <i>*Solo en 8017</i>	-
CHAPA ORO - 0,8.....	-	82,17 €	-	-
CHAPA BRONCE - 0,8.....	-	70,10 €	-	-

CHAPAS TRENZALUNZ

	2x1x1 mm.	2x1x2 mm.	
S/ ANODIZAR	-	100 €	
BLANCA.....	75,20 €	109,30 €	2 CARAS
RAL 6009.....	-	148,55 €	2 CARAS
NOGAL	-	408,20 €	2 CARAS

CHAPAS TREBOL

	2x1x0,8 mm. 2 CARAS
S/ ANODIZAR	47,32 €
BLANCA.....	59,62 €
ORO	99,20 €
NOGAL	343,75 €

CHAPAS DAMERO

2x1x2 mm.....107,07 € 2x1x2 mm.....153,70 €

CHAPAS BLANCA TRENMALIN

2x1x1 mm.....81,32 €

CHAPAS DE SANDWICH CON CHAPAS DE 0,8 MM.

BL+BL 2X1	LISO	RAYA 1 CARA	RAYA 2 CARAS	6009 + 6009 2X1	LISO	RAYA 1 CARA	RAYA 2 CARAS
8 mm.	88,07 €	130,07 €	140,07 €	8 mm.	139,57 €	181,58 €	191,57 €
16 mm.	111,42 €	141,85 €	151,85 €	16 mm.	162,93 €	193,35 €	203,35 €
18 mm.	114,52 €	144,95 €	154,93 €	18 mm.	166,02 €	196,45 €	206,42 €
20 mm.	117,62 €	148,05 €	158,03 €	20 mm.	169,13 €	199,55 €	209,53 €
30 mm.	123,98 €	154,38 €	164,38 €	30 mm.	175,47 €	205,87 €	215,87 €
40 mm.	131,20 €	161,60 €	171,60 €	40 mm.	182,70 €	213,10 €	223,10 €
NOGAL + NOGAL 2X1	LISO	RAYA 1 CARA	RAYA 2 CARAS	NOGAL + 8014 2X1	LISO	RAYA 1 CARA	RAYA 2 CARAS
8 mm.	205,92 €	247,92 €	257,92 €	8 mm.	172,75 €	214,75 €	224,75 €
16 mm.	229,17 €	259,70 €	269,70 €	16 mm.	196,10 €	226,52 €	236,52 €
18 mm.	232,37 €	262,80 €	272,77 €	18 mm.	199,20 €	229,62 €	239,60 €
20 mm.	235,47 €	265,90 €	275,88 €	20 mm.	202,30 €	234,75 €	242,70 €
30 mm.	241,82 €	272,22 €	282,23 €	30 mm.	208,65 €	239,05 €	249,05 €
40 mm.	249,05 €	279,45 €	289,45 €	40 mm.	215,88 €	246,27 €	256,27 €

VISERAS DE 33 MM.

BLANCA.....36 € PLATA36 €

Rayados de 3 - 7 - 10 - 15, en rayados de 10 y 15 se incrementa 50 € el panel.
Disponibilidad en medidas de 3 x 1,25 mm. Consultar precios.
I.V.A. no incluido.

MOTORES

MOTORES PARA PERSIANAS

MOTOR BLUE ROLL	
	TIPO DE ACONDICIONAMIENTO
	 161,50 €

MOTOR BLUE OCEAN	
	TIPO DE ACONDICIONAMIENTO
	 390 €

MOTOR PLUG & PLAY	
	TIPO DE ACONDICIONAMIENTO
	 250 €

BLUE TRONIC	
	TIPO DE ACONDICIONAMIENTO
	 223 €

ACCESORIOS

PULSADOR	
	
	28 €

SKIPPER	
	MANDO A DISTANCIA 1 CANAL
	74 €

SKIPPER PLUS	
	MANDO A DISTANCIA 7 CANALES
	84 €

SKIPPER POCKET	
	MANDO A DISTANCIA DE LLAVERO
	78 €

ÁBACOS PARA PERSIANAS

1 / PESO DE LA PERSIANA

Peso de la persiana = peso/m² x superficie

1a / PESO / M² DE LA LAMA UTILIZADA

TIPO DE LAMA	KG/M ² *
ALUMINIO PERFILADO	4
ALUMINIO EXTRUSIÓN	10
ALUMINIO EXTRUSIÓN AUTOBLOCANTE	14
PVC	5
MADERA	8

* Pesos generales aproximados. Para el peso exacto consulte con el fabricante de la lama. Peso contemplado con eje 50 y lama perfilada, otra lama consultar 'ábacos.

MOTOR 10 NW.....	28 KG.
MOTOR 30 NW.....	60 KG.

TIRANTE	
	ZF / UNIÓN 2E
	5,15 €

ANILLO	
	ZF 50 OCT
	0,54 €

Para cualquier tipo de motor o accesorios consultar precio y disponibilidad.

DECORACIÓN

MAMPARAS



PUERTAS EN ALUMINIO DE SEGURIDAD



TECHOS DE ALUMINIO



CORTINAS VERTICALES



WIND SCREEN



CORTINA PLEGABLE



PANEL DESLIZANTE



TOLDOS



CORTINA PLISADA



STOR ENROLLABLE



VISION



CARTA DE COLORES



BLANCO



RAL 1015



RAL 3007



RAL 1013



RAL 3005



RAL 5010



RAL 6005



RAL 7016



RAL 7035



RAL 6009

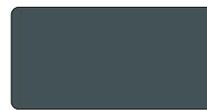

RAL 7012



RAL 8007



RAL 8014



RAL 9006



RAL 9011



RAL 8017



INOX

DESCUENTOS

PÁGINA	CONCEPTO	DTO.
4	PERSIANAS TIPO COMPACTO Y MINI	
6	PAÑOS DE PERSIANAS	
8	ACCESORIOS DE PERSIANAS	
12	MATERIAL EN LARGO DE PERSIANAS	
13	GUÍAS	
14	MOSQUITERAS ENROLLABLES	
15	MOSQUITERAS CORREDERAS	
16	MOSQUITERAS PUERTAS	
17	MATERIAL EN LARGO DE MOSQUITERAS	
18	PERSIANAS DE CADENILLA	
19	VENECIANAS	
20	PUERTAS PLEGABLES DE PVC	
22	CORTINAS	
24	CELOSÍAS	
25	CHAPAS DE ALUMINIO Y VISERAS	
26	MOTORES	
27	VARIOS DECORACIÓN	

Condiciones de venta

Los cobros se realizarán mediante giros domiciliados o al contado en efectivo contra entrega de la mercancía, salvo acuerdo explícito con su comercial de zona. Todos los precios incluidos en esta tarifa no incluyen i.v.a., con lo cual deberán aplicarlo al precio final. Los precios se refieren a la mercancía entregada franco en la sede de la sociedad.

Las partes acuerdan mutuamente de su naturaleza, relativo a la venta, su cumplimiento, ejecución e interpretación será competencia exclusiva de los Tribunales del lugar del domicilio social del vendedor, es decir, Sevilla. Las ofertas de precios de la sociedad Sangeplast, S.L. son válidas por un periodo máximo de 30 días desde la fecha del envío.

HOJA DE PEDIDO

AGENTE **FECHA**

Nombre:	Tif.:
Domicilio:	NIF:
Localidad:	F.Pago:
Referencia:	Pedido por:

PERSIANAS

MEDIDAS					CAJÓN				LAMAS			GUÍAS		SISTEMA DE ELEVACIÓN			OBSERVACIONES
Nº	Ancho	Alto	T	+	AL	PVC	DT/AL	COLOR	AL	PVC	COLOR	MODELO	COLOR	REF.	IZQ.	DCH.	

MOSQUITERAS

Nº	ANCHO	ALTO	COLOR	CORREDERA	ENROLLABLE	33	42	NOTAS

Con el fin de evitar el mayor número de errores posibles, rogamos nos envíen sus pedidos por las siguientes vías:

Fax: 95 438 89 087

E-mail: pedidos@sangeplast.com

WhatsApp: 605 885 982

Sangeplast no se responsabiliza ante posibles incidencias en los pedidos cursados telefónicamente.



SanJePlas[®]
COMPACTOS, PERSIANAS, MOSQUITERAS, MAMPARAS

OFICINAS Y ALMACÉN

Sangeplast, S.L.
Polígono Industrial San Jerónimo,
parcelas 15 y 16
41015 Sevilla
Telf.: 954 37 30 97
Fax: 954 38 89 07
Móvil: 680 434 403
 605 885 982

E-mails:

sangeplast@hotmail.es
pedidos@sangeplast.com
administracion@sangeplast.com
presupuestos@sangeplast.com
direccion@sangeplast.com
comercial@sangeplast.com
www.sangeplast.com

SanJePlas
COMPACTOS, PERSIANAS, MOSQUITERAS, MAMPARAS